



■ Some of the photos may include optional equipment.

HYUNDAI LPG/GASOLINE FORKLIFT TRUCKS **Applied Tier 4 Engine**

25/30/33L(G)-7A

 **HYUNDAI**
CONSTRUCTION EQUIPMENT

Head Office (Sales office)

First tower, 55, Bundang-ro, Bundang-gu, Seongnam-si, Gyeonggi-do, Korea

PLEASE CONTACT

www.hyundai-ce.com

2017. 08 Rev 7

 **HYUNDAI**
CONSTRUCTION EQUIPMENT

NEW criteria of Forklift Trucks

Hyundai introduces a new line of 7A series
LPG / Gasoline forklift trucks.
Excellent power and performance make your
business more profitable.



OPSS (Operator Presence Sensing System)

Control of mast tilting, lifting and lowering is not possible through operation of the appropriate control when the operator is not in the seated position. (Option)

■ Some of the photos may include optional equipment.

The new master on the job-site!

Smooth running, efficient and ergonomically designed, 25/30/33L(G)-7A are made to meet your needs.

44kW/2,300rpm



Powerful Engine HMC L4KB(2.4L) Engine

Market approved quality of HMC L4KB engine ensures incomparable performance, durability and additional value to the machine. Powerful and efficient engine provides excellent fuel consumption and excellent torque improved operator's comfort. (35.7kW/2,300rpm : Gasoline) (EPA/CARB Tier-IV Certified)

Fast and Stable Performance

Being able to quickly raise and lower the mast, as well as tilt it forward and backward, provides the best operational conditions during unloading.

When the truck is fully loaded, mast lowering speed is carefully controlled to ensure safety by the down control valve.

Mast(Lift and Tilt) Look System. (Option)



Some of the photos may include optional equipment.

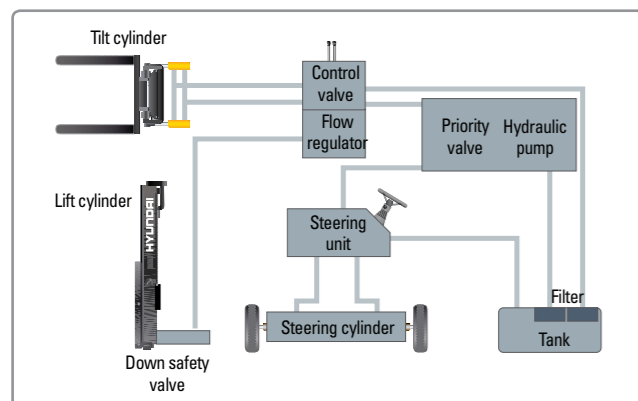

State-of-the-art Hydraulic System

The latest large-capacity hydraulic system reacts quickly during operation, and a low-noise control valve increases both efficiency and durability.



Fully Hydrostatic Power Steering

A hydraulic steering system always guarantees smooth and flexible steering, preventing overrun and kick-back.



Increased Mast Tilting Angle

Utilizing the mast tilting angle of 6 degrees forward and 10 degrees backward, the operator can safely and rapidly perform loading and unloading jobs.

Faster Travel Speed & Better Gradability

The powerful high-output engine provides greater acceleration, better gradability and faster travel speed on any tough terrains or slopes.

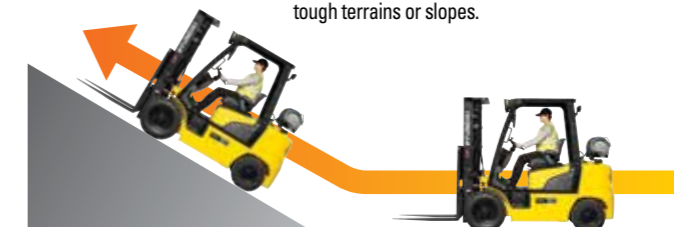

Gradability(Loaded)

25L-7A : 20.4° 25G-7A : 15.2°
30L-7A : 16.6° 30G-7A : 12.4°
33L-7A : 15.4° 33G-7A : 11.5°

Travel Speed(Unloaded)

25L(G)-7A : 17.7 km/h
30L(G)-7A : 18.6 km/h
33L(G)-7A : 18.6 km/h

Ergonomic operator friendly compartment design!

A design based on human engineering relieves fatigue and increases operator's efficiency.

Operator Friendly Gauges and Water-resistant Monitor Panel



- 1 Parking brake lamp
- 2 Directional indicators
- 3 Fuel warning lamp
- 4 Engine oil warning lamp
- 5 Transmission oil temperature warning lamp
- 6 Battery charging warning lamp
- 7 Air cleaner filter warning light
- 8 Working light indicator
- 9 Water temperature gauge
- 10 Fuel gauge
- 11 Hour meter
- 12 Engine check lamp
- 13 Brake oil warning lamp
- 14 Seat belt warning
- 15 OPS warning



New High Visibility for Safe Operation

The operator is able to work with increased safety and accuracy due to a wider view mast.

Full suspension seat



An attractive and adjustable seat, based on a human engineering design, provides great comfort, safety and durability.

Grammer Seat (Option)



- Quick Achievement of the Ergonomically Best Sitting Position
- Asymmetrical Backrest
- Movable Armrests
- Seat Heating
- Practical Document Box



Travel Speed Control System (Option)



- ← In-Door : Max. Travel Speed (5 ~ 16 km/h)
- ← Out-Door : Max Travel Speed (Max Vehicle Speed)

Some of the photos may include optional equipment.



Ergonomically Positioned Pedals

Based on human engineering, the accelerator, brake and inching pedals are optimally positioned for convenience while operating the equipment.



Cup Holder & Console Box

Additional storage spaces are located inside the operating space for operator's convenience.



Quick Response of Operating Control Levers

Only minimal operator's effort is required for precise, safe and productive control.



Adjustable Steering Wheel

Steering wheel with horn button can be adjusted by a lever on the right-hand side for the most comfortable operator position.



Easy and Safe Shift Lever

A single lever on the left side of the steering column gives the operator fast, easy control of direction. The lever must be in the neutral position before the engine can be started.



Secondary Horn

Secondary Horn gives access to lights and horn

Danger-free through high durability!

Safety and durability are priorities in design of the equipment.



Strong Overhead Guard

The safety overhead guard meets ISO 6055 regulation and protects the operator during hazardous jobs.



Parking Brake

Ratchet type parking brake requires less effort from the operator to set.

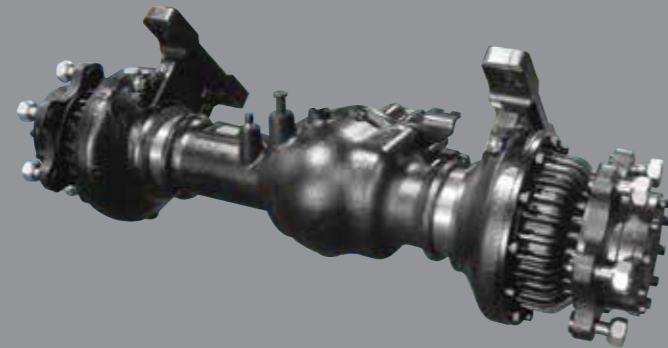

Highly Durable Split Type Drive Axle

The bevel gear set and hub reduction axle smoothly delivers desired torque to the drive wheels.



■ Some of the photos may include optional equipment.



Large Footboard & Hand Grip

Wide "open" step offers convenience and safety when entering and exiting truck.



Expansion Bellows

The expansion bellows absorbs vibration and reduces noise generated from the exhaust gas system and also extends the life cycle of exhaust gas system.



Electrically Monitored Air Filter

Air cleaner sensor alerts the operator of a restricted air filter and allows replacement before damage.



Heavy Duty Single Unit Frame

Heavy duty single unit type frame, designed on the basis of accurate structural analysis, guarantees durability and safety.



Bright, Protected Headlights

Bright, Protected head lights are positioned for exceptional visibility.

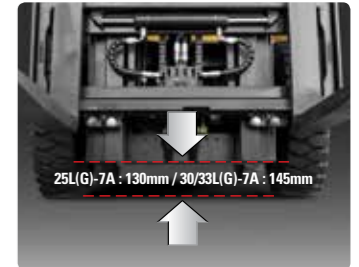

Ground Clearance

The engine and transmission are assembled horizontally and positioned high in the frame to protect major components during operation on rugged surface.

25L(G)-7A : 130mm / 30/33L(G)-7A : 145mm

Designed for quick and easy service!

An ideal arrangement of component parts ensures easy access and convenience for maintenance.



Easy Change Air Cleaner

The air filter is readily accessible for cleaning or replacement. (6inch Cyclone Type)



Fast Service Access for Daily Fluids Check



Rotational Battery Installation



One Touch, No Tool Floor Plate



Removable Side Panels for Ease of Service



Improvement in Maintenance of Electric Parts

Various electric parts are centralized in dash board resulting in effortless troubleshooting.



Easy Maintenance Oil Check

The T/M oil level can be checked easily without any disassembly.



Brake Fluid Reservoir with Level Switch

When brake oil level become lower than Min. the warning lamp on the cluster lights on.



An Accessible, Compact Fuse Box for Easy Inspection

Mast Specification - 25L-7A

Mast Type	Maximum Fork Height		Overall Height Lowered		FREE LIFT						Tilt Angle		Load capacity w/o integral side shift				Load capacity w/integral side shift				TRUCK WEIGHT UNLOAD				
					SINGLE		SINGLE		Fwd deg	Bwd deg	Single Tire		Double Tire		Single Tire		Double Tire		Single Tire		Double Tire				
	with bkr		w/o bkr		w/o bkr (3/4-SPOOL)		24 in LC	500mm LC			24 in LC	500mm LC	24 in LC	500mm LC	24 in LC	500mm LC	lb	kg	lb	kg					
	in	mm	in	mm	in	mm	in	mm	in	mm	deg	deg	lb	kg	lb	kg	lb	kg	lb	kg	lb	kg	lb	kg	
2-STAGE LIMITED FREE LIFT	V300	118.1	3000	79.7	2025	6.1	155	6.1	155	6.1	155	6	10	5000	2500	5000	2500	5000	2500	5000	2500	8127	3687	8560	3883
	+V330	129.9	3300	85.6	2175	6.1	155	6.1	155	6.1	155	6	10	5000	2500	5000	2500	5000	2500	5000	2500	8171	3706	8603	3902
	V350	137.8	3500	89.6	2275	6.1	155	6.1	155	6.1	155	6	10	5000	2500	5000	2500	5000	2500	5000	2500	8208	3723	8641	3919
	V370	145.7	3700	95.5	2425	6.1	155	6.1	155	6.1	155	6	10	5000	2500	5000	2500	4820	2450	5000	2500	8257	3745	8689	3941
	V400	157.4	4000	101.4	2575	6.1	155	6.1	155	6.1	155	6	10	4930	2450	5000	2500	4750	2350	4820	2450	8323	3775	8755	3971
	V430	169.3	4300	107.3	2725	6.1	155	6.1	155	6.1	155	6	6	4850	2400	5000	2475	4670	2300	4820	2350	8437	3827	8869	4023
	V450	177.2	4500	113.2	2875	6.1	155	6.1	155	6.1	155	6	6	4740	2350	4938	2425	4560	2250	4758	2325	8485	3849	8918	4045
2-STAGE FULL	V470	185.0	4700	117.1	2975	6.1	155	6.1	155	6.1	155	6	6	4630	2325	4850	2400	4450	2200	4670	2300	8517	3863	8950	4060
	V500	196.9	5000	123.0	3125	6.1	155	6.1	155	6.1	155	6	6	4400	2250	4630	2350	4220	2150	4450	2250	8566	3885	8998	4082
	VF295	116.1	2950	79.7	2025	33.3	845	54.2	1377	48.1	1221	6	6	5000	2500	5000	2500	5000	2500	5000	2500	8229	3732	8663	3929
	VF325	127.9	3250	85.6	2175	39.2	995	60.1	1527	54.0	1371	6	6	5000	2500	5000	2500	5000	2500	5000	2500	8302	3766	8737	3963
	TF370	145.7	3700	71.9	1825	25.4	645	46.3	1177	45.1	1146	6	6	4930	2460	5000	2500	4750	2350	4820	2500	8428	3823	8862	4020
	TF400	157.4	4000	75.8	1925	29.3	745	50.3	1277	49.1	1246	6	6	4820	2400	4930	2475	4640	2300	4750	2350	8481	3847	8915	4044
	TF430	169.3	4300	79.7	2025	33.3	845	54.2	1377	53.0	1346	6	6	4710	2350	4850	2425	4530	2250	4670	2300	8521	3865	8955	4062
3-STAGE FULL FREE LIFT	TF450	177.2	4500	83.7	2125	37.2	945	58.1	1477	58.1	1477	6	6	4540	2300	4760	2375	4360	2200	4580	2275	8569	3887	9004	4084
	TF470	185.0	4700	85.6	2175	39.2	995	60.1	1527	58.9	1496	6	6	4400	2250	4670	2350	4220	2150	4490	2250	8599	3900	9033	4097
	TF500	196.9	5000	89.6	2275	43.1	1095	64.1	1627	62.8	1596	6	6	3520	2200	4580	2275	3340	2100	4400	2150	8648	3923	9082	4120
	TF550	216.5	5500	97.4	2475	51.0	1295	71.9	1827	71.9	1827	6	6	2640	1700	4400	2200	2460	1650	4220	2100	8734	3962	9168	4159
	TF600	236.2	6000	105.3	2675	58.9	1495	79.8	2027	79.8	2027	6	6	1760	1150	3520	2100	1580	1100	3340	2050	8877	4027	9311	4224
	TS370	145.7	3700	71.9	1825	25.4	645	46.3	1177	41.5	1053	6	6	4930	2460	5000	2500	4750	2350	4820	2500	8428	3823	8862	4020
	TS400	157.4	4000	75.8	1925	29.3	745	50.3	1277	45.4	1153	6	6	4820	2400	4930	2475	4640	2300	4750	2350	8481	3847	8915	4044
	TS430	169.3	4300	79.7	2025	33.3	845	54.2	1377	49.3	1253	6	6	4710	2350	4850	2425	4530	2250	4670	2300	8521	3865	8955	4062
	TS450	177.2	4500	83.7	2125	37.2	945	58.1	1477	55.2	1403	6	6	4540	2300	4760	2375	4360	2200	4580	2275	8569	3887	9004	4084
	TS470	185.0	4700	85.6	2175	39.2	995	60.1	1527	55.2	1403	6	6	4400	2250	4670	2350	4220	2150	4490	2250	8599	3900	9033	4097
	TS500	196.9	5000	89.6	2275	43.1	1095	64.1	1627	59.2	1503	6	6	3520	2200	4580	2275	3340	2100	4400	2150	8648	3923	9082	4120
	TS550	216.5	5500	97.4	2475	51.0	1295	71.9	1827	69.0	1753	6	6	2640	1700	4400	2200	2460	1650	4220	2100	8734	3962	9168	4159
	TS600	236.2	6000	105.3	2675	58.9	1495	79.8	2027	76.9	1953	6	6	1760	1150	3520	2100	1580	1100	3340	2050	8877	4027	9311	4224
	4-STAGE FULL FREE LIFT	QF610	240.7	6115	85.0	2160	39.3	997	59.5	1512	57.6	1462	3	3	3310	1600	3810	1850	3170	1530	3520	1750	9341	4237	9773
QF660		260.4	6615	92.9	2360	47.1	1197	67.4	1712	65.4	1662	3	3	3110	1500	3590	1750	2950	1430	3420	1650	9471	4296	9903	4492
QF700		276.2	7015	96.8	2460	51.1	1297	71.3	1812	69.4	1762	3	3	2910	1400	3510	1700	2780	1330	3310	1600	9539	4327	9971	4523
QF745		293.9	7465	102.8	2610	57.0	1447	75.4	1915	69.4	1762	3	3	2290	1100	3310	1600	2160	1040	3150	1510	9641	4373	10073	4569
QF790	311.6	7915	108.7	2760	62.9	1597	75.4	1915	69.4	1762	3	3	1480	700	2090	1000	1370	650	1920	920	9861	4473	10293	4669	

* TS-Mast : Wide Visible 3 Stage Full Free Lift Mast with 2 Free Lift Cylinders.

Load Capacity

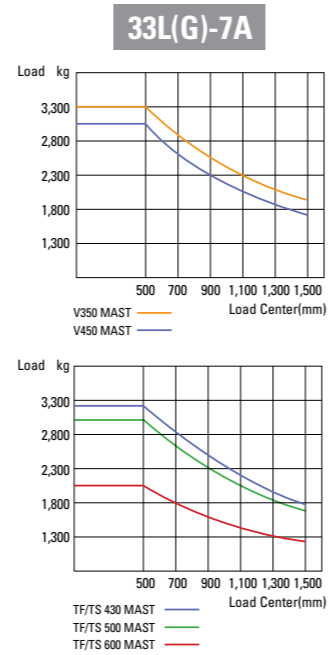
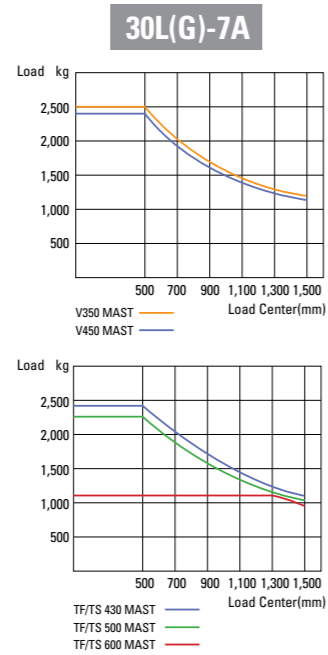
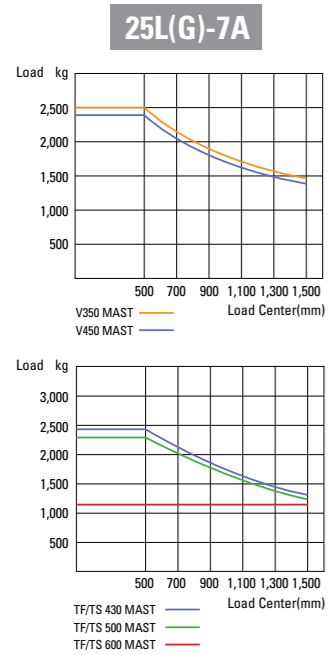

Optional Items

- CABIN & HEATER
- SIDE SHIFT / INTEGRAL SIDE SHIFT
- OVER SHOE(mm) : 1,300, 1,500, 1,700, 1,800
- FORK (L x W x T) (mm)
25L(G)-7A
 900 x 100 x 45 1,000 x 100 x 45 1,050 x 100 x 45
 1,200 x 100 x 45 1,350 x 100 x 45 1,500 x 100 x 45
 1,650 x 100 x 45 1,800 x 100 x 45

- **30/33L(G)-7A**
 900 x 122 x 45 1,050 x 122 x 45 1,150 x 122 x 45
 1,200 x 122 x 45 1,350 x 122 x 45 1,500 x 122 x 45
 1,650 x 122 x 45 1,800 x 122 x 45 1,970 x 122 x 45
 2,120 x 122 x 45 2,300 x 122 x 45 2,400 x 122 x 45
- **TILTING** : 6/6°, 3/3°
- **TIRE** : No-marking, Double
- **SEAT** : Pocket, Belt, Arm Rest, Hip Rest

- **LPG TANK CLAMP** : Swing Out, Swing Down
- **M.C.V** : 4-Spool
- **ATTACH PIPING** : 3 Spool-piping, 4 Spool-piping
- **MASTER SWITCH / HAZARD SWITCH**
- **BEACON LAMP / WORK LAMP**
- **TRAVEL SPEED CONTROL SENSOR**
- **TS-MAST**
- **PRECLANER**

Dimension

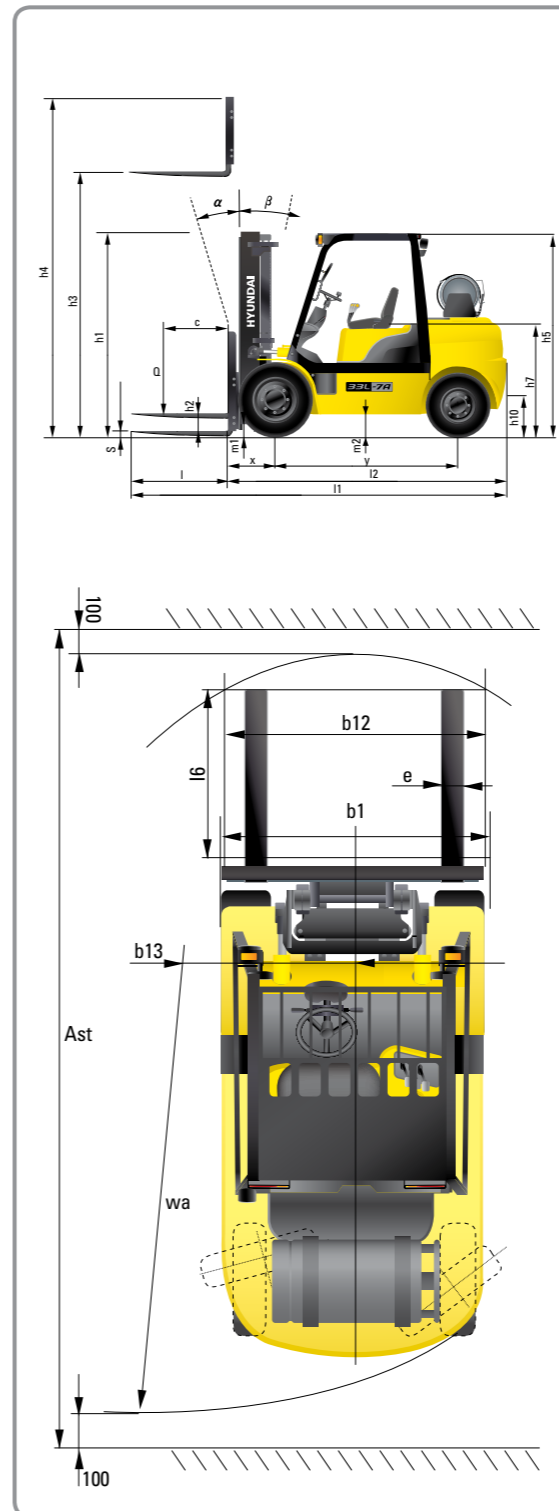

Specification

Identification			
1.1	Manufacturer	Hyundai	Hyundai
1.2	Manufacturer's type designation	25L(G)-7A	30L(G)-7A
1.3	Drive: electric (battery or mains),diesel,petrol,fuel gas>manual	LP / GAS	LP / GAS
1.4	Type of operation:hand,pedestrian,standing,seated,order-picker	seated	seated
1.5	Load capacity / rated load	Q (kg)	3,000
1.6	Load center distance	c (mm)	500
1.8	Load distance, center of drive axle to fork	x (mm)	468
1.9	Wheelbase	y (mm)	1,700
Weights			
2.1	Service weight	kg	3,706
2.2	Axle loading, loaded front/rear	kg	5,452 / 753
2.3	Axle loading, unloaded front/rear	kg	1,486 / 2,220
Wheels, Chassis			
3.1	Tires:solid rubber, superplastic, pneumatic, polyurethane	Pneumatic	Pneumatic
3.2	Tires size, front	7.00 - 12 - 12PR	8.15 x 15 - 14PR
3.3	Tires size, rear	6.50 - 10 - 12PR	6.50 - 10 - 12PR
3.5	Wheels, number front x rear (x = driven wheels)	2 x 2	2 x 2
3.6	Track width, front	b10 (mm)	965
3.7	Track width, rear	b11 (mm)	980
Basic Dimensions			
4.1	Mast / fork carriage tilt forward / backward(α / β)	degrees	6 / 10
4.2	Lowered mast height	h1 (mm)	2,175
4.3	Free lift	h2 (mm)	155
4.4	Lift height	h3 (mm)	3,300
4.5	Extended mast height	h4 (mm)	4,485
4.7	Overhead load guard (cab) height	h5 (mm)	2,160
4.8	Seat height / standing height	h7 (mm)	1,110
4.12	Coupling height	h10 (mm)	283
4.19	Overall length	l1 (mm)	3,644
4.20	Length to face of forks	l2 (mm)	2,594
4.21	Overall width	b1 (mm)	1,160
4.22	Fork dimensions	l / e / s (mm)	1,050 x 100 x 45
4.23	Fork carriage ISO 2328, class / type A,B	II / A	III / A
4.24	Fork-carriage width	b12 (mm)	1,102
4.31	Ground clearance, loaded, under mast	m1 (mm)	130
4.32	Ground clearance, centre of wheelbase	m2 (mm)	171
4.33	Aisle width for pallets 1000 x 1200 crossways	Ast (mm)	3,966
4.34	Aisle width for pallets 800 x 1200 lengthways	Ast (mm)	4,166
4.35	Turning radius	Wa (mm)	2,298
4.36	Smallest pivot point distance	b13 (mm)	714
Performance Data			
5.1	Travel speed, Unloaded	km/h	17.7
5.2	Lift speed, Loaded/Unloaded	mm/s	600 / 610
5.3	Lowering speed, Loaded/Unloaded	mm/s	500 / 450
5.5	Drawbar pull, Loaded	kg	2,412
5.7	Gradient performance, Loaded	%	37.1
5.9	Acceleration time, loaded/unloaded (10m)	sec	NA
5.10	Service brake		FOOT
Engine			
6.1	Engine manufacturer / type		HMC L4KB
6.2	Engine power acc. to ISO 1585 (gasoline)	kW	44 (35.7)
6.3	Rated speed	1/min	2,300
6.4	No. of cylinder / cubic capacity	/cm ³	4 / 2,359
Other Details			
8.2	Type of drive control		Power Shift
8.3	Operating pressure	bar	220 / 165
8.4	Oil volume	ℓ	30
8.5	Noise	db(A)	80